

**Produit, caractéristiques techniques et fonctionnalités**

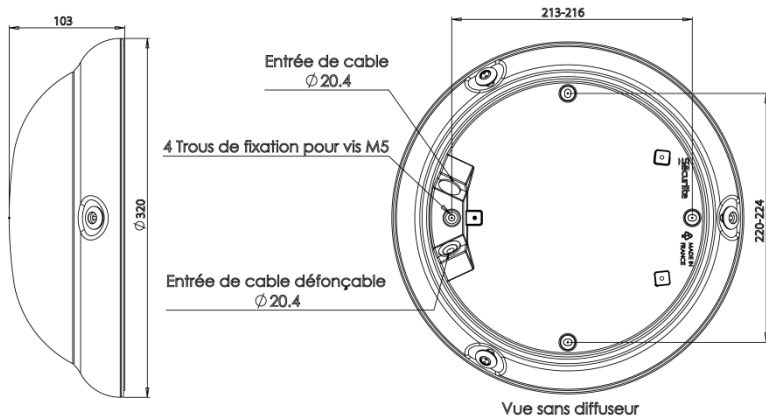

**Kit d'installation standard:**

Gaines isolation bornier secteur **x2**  
Passe fils **x1**  
Bouchons de protection **x4**  
Cache vis **x3**  
Visserie **x3**

**Caractéristiques générales:**

Tension nominale: **220 - 240V AC – 50 / 60 Hz**  
Plage de tension d'entrée: **198V – 264V AC**  
Classe de protection: **II**  
Indice de protection: **IP 55**  
Indice de résistance aux chocs mécaniques: **IK11 / 50J**

**Source lumineuse:**

**LED** - ce produit contient une source lumineuse de classe d'efficacité énergétique C.

**E27** - ce produit contient une source lumineuse de classe d'efficacité énergétique F.

**Puissance(s):** Se reporter à l'étiquette produit.









**Référence(s):** Se reporter à l'étiquette produit.

- Réf. Générique: 15xxx**00** sans détection (se reporter à cette notice).
- Réf. avec terminaison optionnelle (se reporter à la notice complémentaire).

**Autre(s) référence(s) avec option(s):**

- Se reporter aux notices complémentaires.

**Conditions d'utilisation**

						
E27	OK	OK	 Max. :  Led 11W		X	X
LED	OK	OK	OK	OK	X	X

**Montage / Installation**



Attention, risque de chocs ESD sur les LEDs.



Le montage et l'installation doit être fait par un installateur professionnel en respectant les normes d'installation en vigueur.



Couper l'alimentation avant la pose et le branchement.

**Ouverture lumineuse:**



Déposer le diffuseur

## Montage / Installation (suite)

### Préparation passage et entrée de câble:

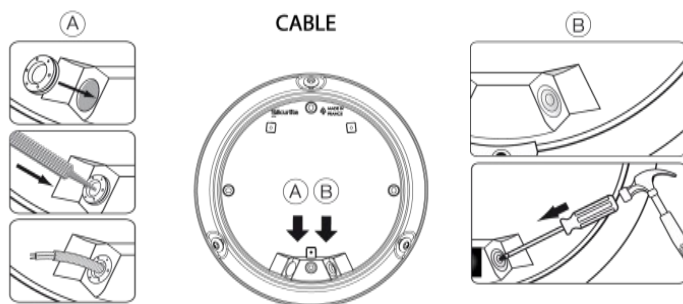

Afin de garantir l'étanchéité du luminaire l'utilisation des passes-fils est impérative.

Utiliser un câble de type U1000R2V 1.5mm<sup>2</sup> (préconisé pour le respect de l'étanchéité).

Percer un passe fils en son centre à l'aide d'une pointe. Ne pas utiliser de lame qui pourrait fragiliser le passe fils et nuire à l'étanchéité.

Monter le passe fils dans l'entrée de câble et introduire le câble d'alimentation au travers de celui-ci.

### Fixation:

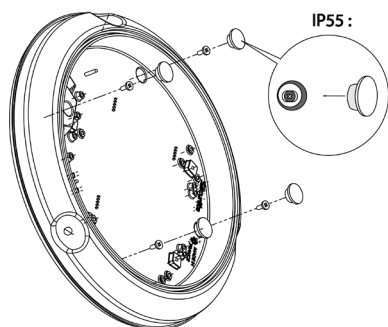

Pour la fixation du luminaire, utiliser des vis de diamètre 5mm à tête plate et des chevilles adaptées au type de paroi pour avoir une résistance optimale à l'arrachement. Les vis et chevilles ne sont pas fournies avec le luminaire.

Positionner les 4 bouchons afin de respecter l'étanchéité du produit.

### Raccordement électrique (Réf. Générique 15xxx00):

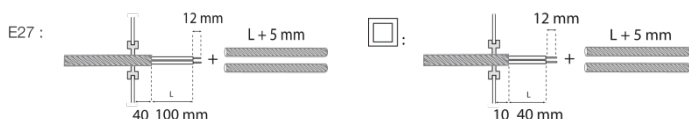

Le câble devra être dénudé selon schémas.

Les fils devront être dénudés sur une longueur de 12mm.

Les gaines de protection fournies dans le kit devront être enfilées sur les fils pour le respect de la classe II.

Respecter la polarité.

### Repiquage 16A Max.

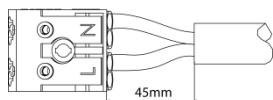

➤ Pour autres cas, se reporter aux notices particulières pour raccordement et repiquage.

### Fermeture du luminaire:

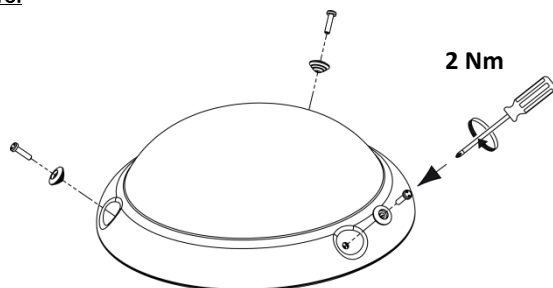



## Entretien

L'entretien du luminaire se limite à un nettoyage du diffuseur pour une bonne luminosité, nettoyer le diffuseur (luminaire fermé) avec un chiffon humide ou à l'eau savonneuse.

 **NE PAS UTILISER DE DETERGENT**

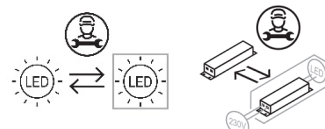
## Maintenance



 La source lumineuse et l'appareillage contenus dans ce luminaire ne doivent être remplacés que par le fabricant, son agent de service ou une personne de qualification équivalente.

## Recyclabilité



### *Le BANG ROND est un luminaire éco-conçu:*

- Toutes les pièces plastiques ou métalliques peuvent être démontées et recyclées dans une filière adaptée.
- Tous les composants électroniques tels que le circuit LED, l'alimentation, etc ... peuvent être démontés et recyclés dans une filière adaptée.

Z.I des Ajeux - 72400 La Ferté-Bernard - France  
Tél. : +33 (0)2 43 60 40 00 / Fax : +33 (0)2 43 60 40 09

 [www.securlite.com](http://www.securlite.com)

## Product, technical characteristics and features

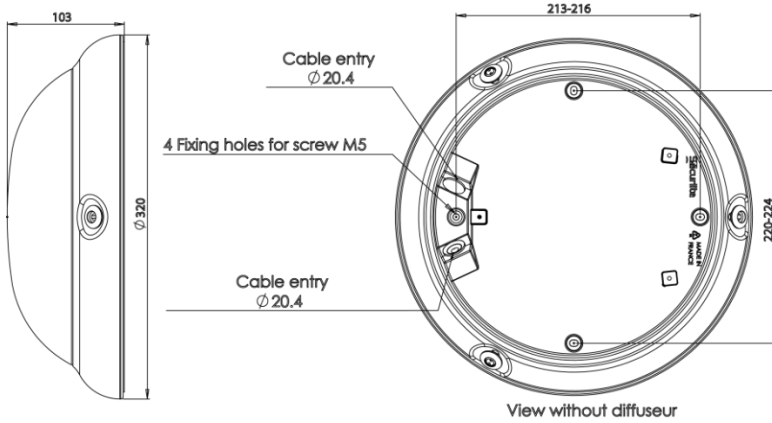

### Standard installation kit:

- Mains terminal block insulating sleeves **x2**
- Cable grommet **x1**
- Protective blanking plugs **x4**
- Screw covers **x3**
- Fixing screws **x3**

### General characteristics:

- Nominal voltage: **220 - 240V AC – 50 / 60 Hz**
- Input voltage range: **198V – 264V AC**
- Protection class: **II**
- Protection rating: **IP 55**
- Mechanical impact resistance rating: **IK11 / 50 J**

### Light source:

- LED - this product contains a light source of energy efficiency class C.
- E27 - this product contains a light source of energy efficiency class F.

**Power(s):** as per label product.









**Reference(s):** as per label product.

- Standard reference: 15xxx**00** no detection (see this instruction).
- Options regarding the end of product's reference (see specific instructions).

**Other reference(s) with option(s):**

- See specific instructions.

## Conditions of use

						
E27	OK	OK	 Max. :  Led 11W		X	X
LED	OK	OK	OK	OK	X	X

## Mounting / Installation



*Warning, versions employing LEDs are at risk from ESD (electrostatic discharges).*



*Fitting & installation must be carried out by a professional installer in accordance with current installation standards.*



*Isolate the power before fitting and connecting up.*

**Opening the luminaire:**

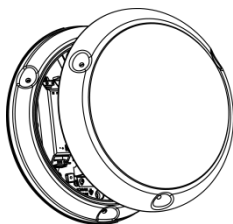

Remove diffuser.

## Mounting / Installation

### Preparing the cable entry grommet:

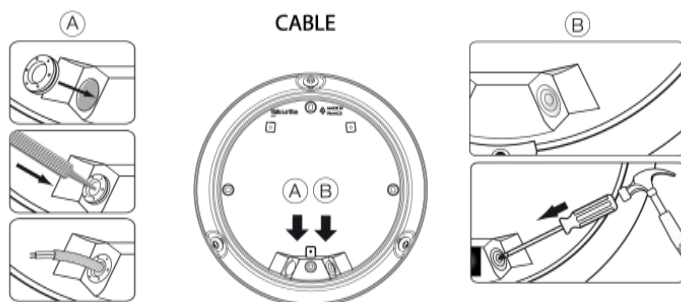

In order to ensure the luminaire is sealed, it is vital to use the cable grommets.

Use 1.5 mm<sup>2</sup> U1000R2V type cable (recommended to maintain sealing).

Use a pointed object to pierce the centre of a cable grommet. Do not use a blade, which might weaken the grommet and impair sealing.

Fit the grommet into the cable entry and feed the supply cable through it.

### Fixing:

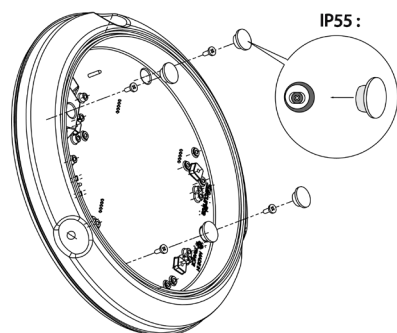

For mounting the luminaire, use 5 mm diameter flat-headed screws with fixing plugs suitable for the type of wall, in order to achieve optimum rip-out resistance. The screws and plugs are not supplied with the luminaire.

Fit the 4 blanking plugs in order to maintain the sealing of the product.

### Electrical connection (Standard reference 15xxx00):

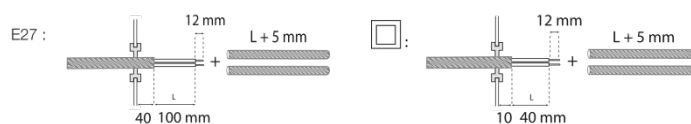

The cable must be prepared as per the diagrams.

The conductors must be stripped for a length of 12 mm.

The protective sleeves supplied with the kit must be threaded onto the wires, to comply with the Class II requirements.

Respect the polarity.

Max. splitting feed : 16A.

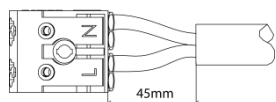

- For other cases, refer to the specific instructions for connection and splitting off.

### Closing the luminaire:

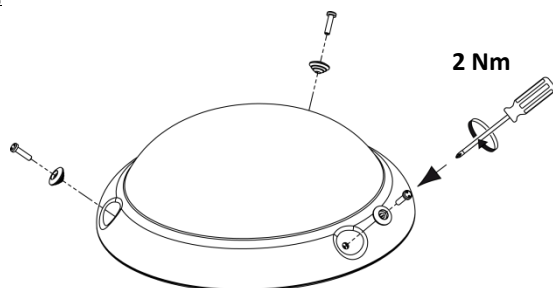

## Cleaning

Cleaning of the luminaire is limited to cleaning the diffuser for proper light output. Clean the diffuser (with the luminaire closed) using a damp cloth or with soapy water.

 **DO NOT USE DETERGENT**

## Maintenance

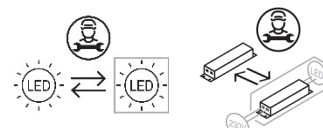

The light source and the control gear contained in this luminaire must only be replaced by the manufacturer or his service agent or a similar qualified person.

## Recyclability



**The BANG is an eco-designed luminaire:**

- All the plastic or metal components can be dismantled and recycled via appropriate facilities.
- All the electronic components such as the LED circuit, power supply, etc. can be dismantled and recycled via appropriate facilities.